



Tradensa
TOOLS AND MACHINE PARTS

 **Gisstec**[®]



NUTSTOßEN & VERZÄHNUNG

ĐŁUTOWANIE ROWKÓW WPUSTOWYCH, WIELOKĄTÓW, KÓŁ
ZĘBATYCH I WIELOWYPUSTÓW



www.gisstec.com / www.tradensa.pl

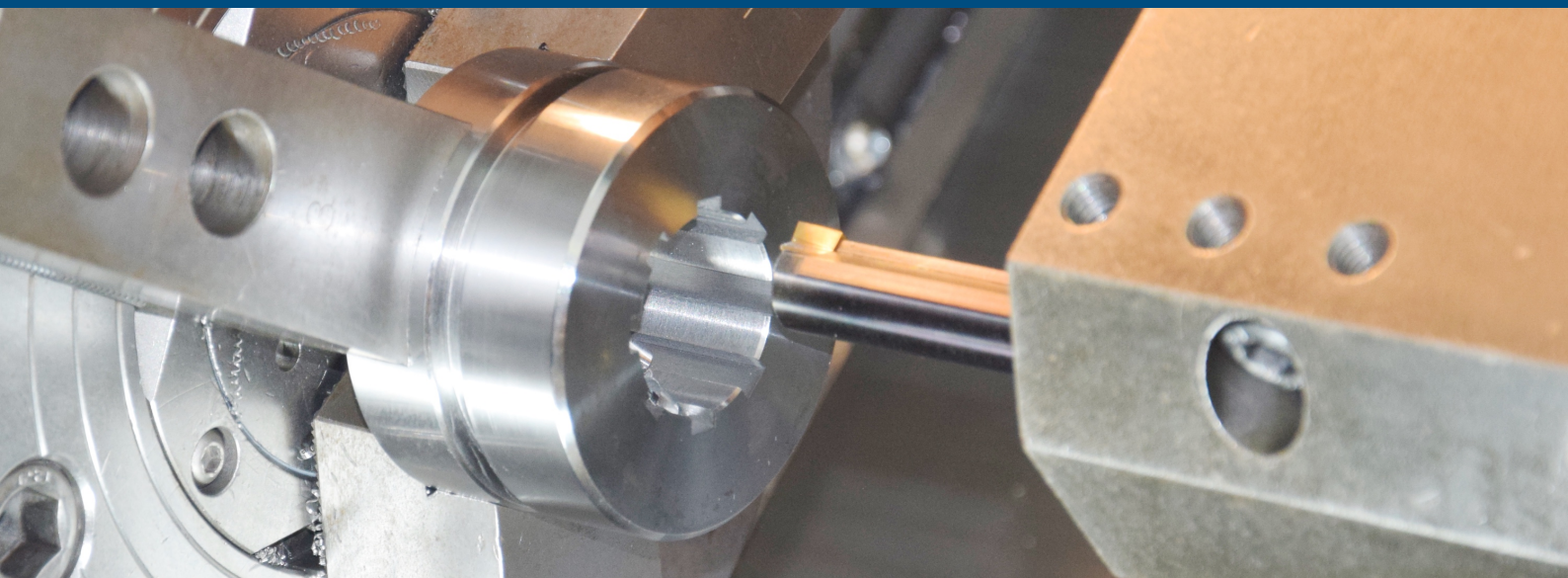

Nutstoßwerkzeuge

- ✓ Ideale Lösung für Nutstoßen auf Bearbeitungszentren und Drehmaschinen
- ✓ Werkzeughalter aus gehärtetem Werkzeugstahl
- ✓ Plattensitz gehärtet: 58-60 HRC
- ✓ Ø3,5 Bohrungen für Kühlmittelzuführung
- ✓ Sonderwerkzeuge auf Anfrage

Narzędzia do dłutowania

- ✓ Idealne rozwiązanie do wykonywania rowków na tokarkach i frezarkach CNC
- ✓ Oprawki narzędziowe wykonane z hartowanej stali narzędziowej
- ✓ Gniazdo uchwytu jest hartowane na 58-60 HRC
- ✓ Otwory chłodzące o średnicy Ø3,5mm
- ✓ Szybka dostawa narzędzi specjalnych na zamówienie

Katalogartikel
ab Lager
lieferbar

Pozycje katalogowe
dostępne od ręki
z magazynu

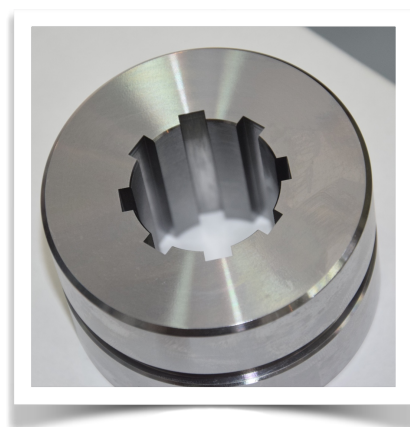

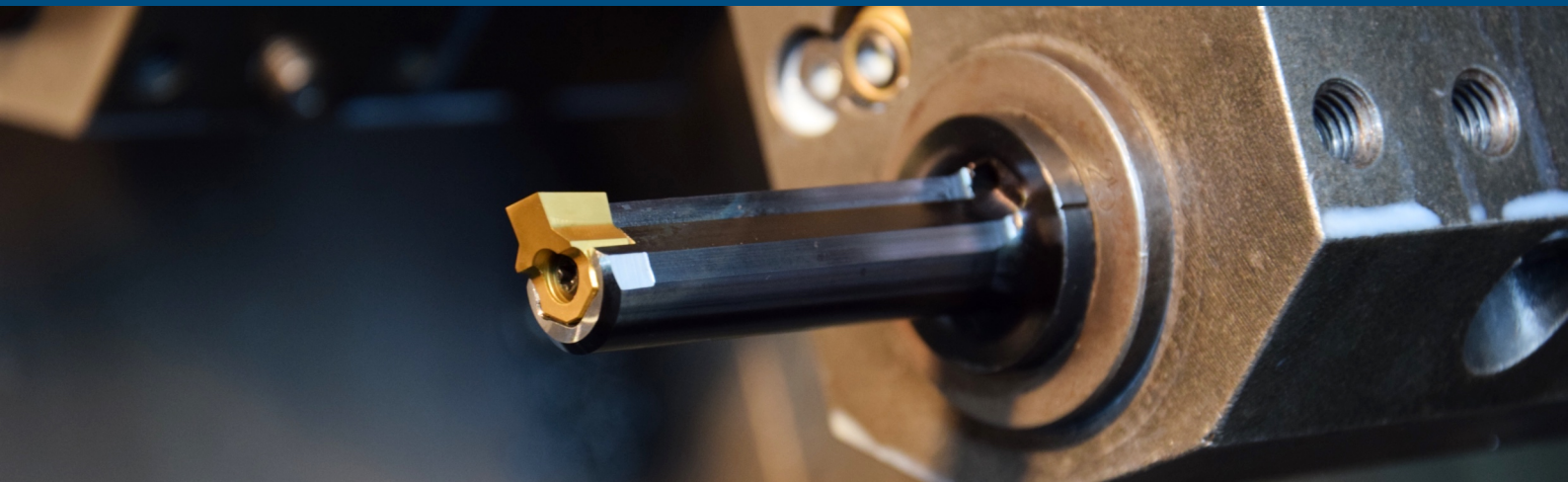

Nutstoßplatten

- ✓ Gesinterte HSS-Legierung mit Cobalt
- ✓ Höhere Leistung als Hartmetall
- ✓ Härte: 72 HRC
- ✓ TIN beschichtet
- ✓ Mehrmaliges Nachschleifen möglich
- ✓ Sonderplatten kurzfristig lieferbar



UT-X

Werkzeug / Narzędzie

+



IN-X

Platte / Płytką

X: Nutenbreite / Szerokość rowka wpustowego

Płytki do dłutaków

- ✓ Spiekana stal HSS z kobaltem
- ✓ Wydajność lepsza niż w przypadku węglików spiekanych
- ✓ Twardość: 72 HRC
- ✓ Pokryte azotkiem tytanu TiN
- ✓ Możliwość wielokrotnego ostrzenia
- ✓ Szybka dostawa płytek specjalnych

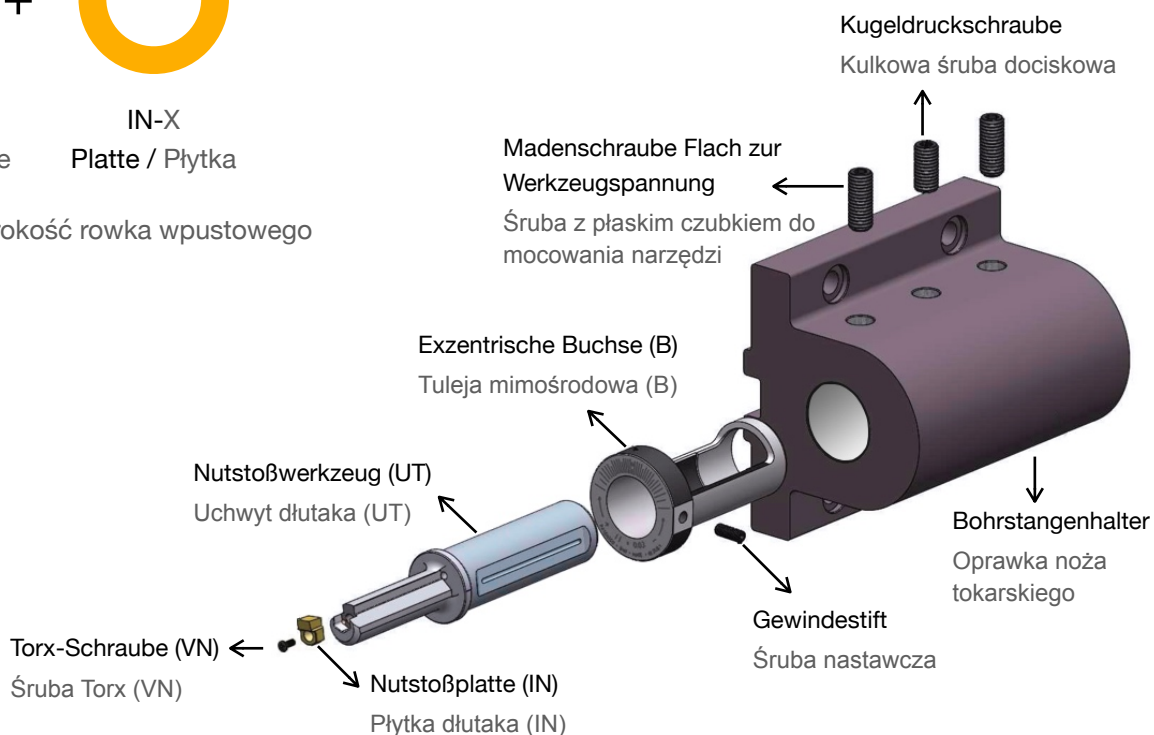



2 - 25 mm
3/32" - 3/4"

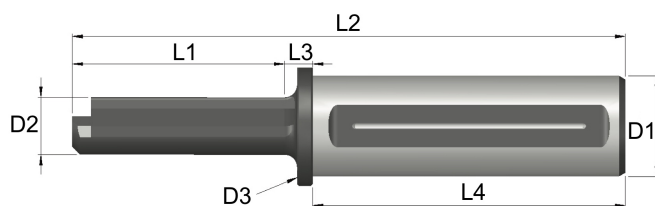

Längsnut

Rowek wpustowy wzdłużny

Halter Uchwyt	L1 mm	L2 mm	L3 mm	L4 mm	D1 mm	D2 mm	D3 mm	PN	T	VN	Min Ø mm
UT-02-25	25	124	9	90	25	6	30	PN-1	T08	VN-1	7
UT-02-25-L	34,5	133,5	9	90	25	6	30	PN-1	T08	VN-1	7
UT-03-25	30	129	9	90	25	8	30	PN-1	T08	VN-1	8,7
UT-03-25-L	40	139	9	90	25	8	30	PN-1	T08	VN-1	8,7
UT-04-25	40	139	9	90	25	10	30	PN-1	T08	VN-1	11
UT-04-25-L	56	155	9	90	25	10	30	PN-1	T08	VN-1	11
UT-05-25	46	145	9	90	25	12	30	PN-1	T08	VN-1	13
UT-05-25-L	66	165	9	90	25	12	30	PN-1	T08	VN-1	13
UT-06-25	56	155	9	90	25	16	30	PN-2	T15	VN-2	17,5
UT-06-25-L	81	180	9	90	25	16	30	PN-2	T15	VN-2	17,5
UT-08-25	68	167	9	90	25	20	30	PN-2	T15	VN-2	21,5
UT-08-25-L	100	199	9	90	25	20	30	PN-2	T15	VN-2	21,5
UT-10-25	86	185	9	90	25	25	30	PN-3	T20	VN-3	28
UT-10-25-L	126	225	9	90	25	25	30	PN-3	T20	VN-3	28
UT-12-25	104	203	9	90	25	30	30	PN-3	T20	VN-3	32
UT-12-25-L	161	260	9	90	25	30	30	PN-3	T20	VN-3	32
UT-14/16-25	126	221	5	90	25	35	37	PN-4	T20	VN-3	37
UT-14/16-25-L	180	285	5	100	35	25	37	PN-4	T20	VN-3	37
UT-02-32	25	134	9	100	32	6	37	PN-1	T08	VN-1	7
UT-02-32-L	34,5	143,5	9	100	32	6	37	PN-1	T08	VN-1	7
UT-03-32	30	139	9	100	32	8	37	PN-1	T08	VN-1	8,7
UT-03-32-L	40	149	9	100	32	8	37	PN-1	T08	VN-1	8,7
UT-04-32	40	149	9	100	32	10	37	PN-1	T08	VN-1	11
UT-04-32-L	56	165	9	100	32	10	37	PN-1	T08	VN-1	11
UT-05-32	46	155	9	100	32	12	37	PN-1	T08	VN-1	13
UT-05-32-L	66	175	9	100	32	12	37	PN-1	T08	VN-1	13
UT-06-32	56	165	9	100	32	16	37	PN-2	T15	VN-2	17,5
UT-06-32-L	81	190	9	100	32	16	37	PN-2	T15	VN-2	17,5
UT-08-32	68	177	9	100	32	20	37	PN-2	T15	VN-2	21,5
UT-08-32-L	100	209	9	100	32	20	37	PN-2	T15	VN-2	21,5
UT-10-32	86	195	9	100	32	25	37	PN-3	T20	VN-3	28
UT-10-32-L	126	235	9	100	32	25	37	PN-3	T20	VN-3	28
UT-12-32	104	213	9	100	32	30	37	PN-3	T20	VN-3	32
UT-12-32-L	161	270	9	100	32	30	37	PN-3	T20	VN-3	32
UT-14/16-32	126	235	9	100	32	35	37	PN-4	T20	VN-3	37
UT-14/16-32-L	180	289	9	100	32	35	37	PN-4	T20	VN-3	37
UT-18/25-32	140	249	9	100	32	40	45	PN-5	BR5	VN-4	45
UT-18/25-32-L	200	309	9	100	32	40	45	PN-5	BR5	VN-4	45



2 - 10 mm

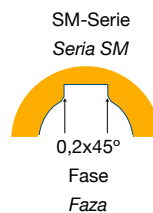
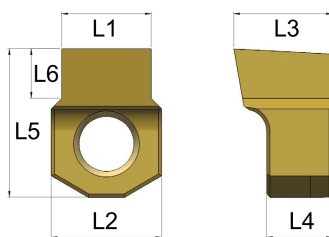

Längsnut

Rowek wpustowy wzdłużny

Platte Płytką	L1 mm	L2 mm	L3 mm	L4 mm	L5 mm	L6 mm	UT	RF
IN-02-P6/P9	1,994	5	6,5	5	6,5	1,3	UT-02	RF-1
IN-02-P6/P9-SM	1,994	5	6,5	5	6,5	1,09	UT-02	RF-1
IN-02-H7/JS9	2,010	5	6,5	5	6,5	1,3	UT-02	RF-1
IN-02-H7/JS9-SM	2,010	5	6,5	5	6,5	1,09	UT-02	RF-1
IN-02-D10	2,060	5	6,5	5	6,5	1,3	UT-02	RF-1
IN-02-C11	2,120	5	6,5	5	6,5	1,3	UT-02	RF-1
IN-03-P6/P9	2,994	6,08	6,5	5	7,5	2	UT-03	RF-1
IN-03-P6/P9-SM	2,994	6,08	6,5	5	7,5	1,42	UT-03	RF-1
IN-03-H7/JS9	3,010	6,08	6,5	5	7,5	2	UT-03	RF-1
IN-03-H7/JS9-SM	3,010	6,08	6,5	5	7,5	1,42	UT-03	RF-1
IN-03-D10	3,060	6,08	6,5	5	7,5	2	UT-03	RF-1
IN-03-C11	3,120	6,08	6,5	5	7,5	2	UT-03	RF-1
IN-04-P6/P9	3,988	6,08	7	5	8	2,6	UT-04	RF-1
IN-04-P6/P9-SM	3,988	6,08	7	5	8	2,07	UT-04	RF-1
IN-04-H7/JS9	4,012	6,08	7	5	8	2,6	UT-04	RF-1
IN-04-H7/JS9-SM	4,012	6,08	7	5	8	2,07	UT-04	RF-1
IN-04-D10	4,078	6,08	7	5	8	2,6	UT-04	RF-1
IN-04-C11	4,145	6,08	7	5	8	2,6	UT-04	RF-1
IN-05-P6/P9	4,988	6,08	7	5	8	3	UT-05	RF-1
IN-05-P6/P9-SM	4,988	6,08	7	5	8	2,74	UT-05	RF-1
IN-05-H7/JS9	5,012	6,08	7	5	8	3	UT-05	RF-1
IN-05-H7/JS9-SM	5,012	6,08	7	5	8	2,74	UT-05	RF-1
IN-05-D10	5,078	6,08	7	5	8	3	UT-05	RF-1
IN-05-C11	5,145	6,08	7	5	8	3	UT-05	RF-1
IN-06-P6/P9	5,988	10,08	9	6	13,5	4	UT-06	RF-2
IN-06-P6/P9-SM	5,988	10,08	9	6	13,5	3	UT-06	RF-2
IN-06-H7/JS9	6,012	10,08	9	6	13,5	4	UT-06	RF-2
IN-06-H7/JS9-SM	6,012	10,08	9	6	13,5	3	UT-06	RF-2
IN-06-D10	6,078	10,08	9	6	13,5	4	UT-06	RF-2
IN-06-C11	6,145	10,08	9	6	13,5	4	UT-06	RF-2
IN-08-P6/P9	7,985	10,08	9	6	13,5	4,5	UT-08	RF-2
IN-08-P6/P9-SM	7,985	10,08	9	6	13,5	3,78	UT-08	RF-2
IN-08-H7/JS9	8,015	10,08	9	6	13,5	4,5	UT-08	RF-2
IN-08-H7/JS9-SM	8,015	10,08	9	6	13,5	3,78	UT-08	RF-2
IN-08-D10	8,098	10,08	9	6	13,5	4,5	UT-08	RF-2
IN-08-C11	8,170	10,08	9	6	13,5	4,5	UT-08	RF-2
IN-10-P6/P9	9,985	13,1	14	10	18,5	6	UT-10	RF-3
IN-10-P6/P9-SM	9,985	13,1	14	10	18,5	3,88	UT-10	RF-3
IN-10-H7/JS9	10,015	13,1	14	10	18,5	6	UT-10	RF-3
IN-10-H7/JS9-SM	10,015	13,1	14	10	18,5	3,88	UT-10	RF-3
IN-10-D10	10,098	13,1	14	10	18,5	6	UT-10	RF-3
IN-10-C11	10,170	13,1	14	10	18,5	6	UT-10	RF-3

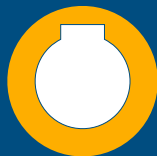

12 - 25 mm

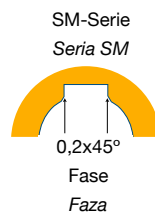
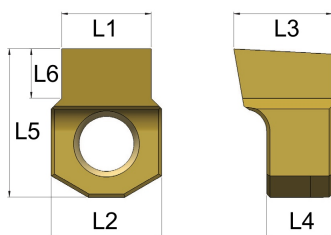

Längsnut

Rowek wpustowy wzdłużny

Platte Płytką	L1 mm	L2 mm	L3 mm	L4 mm	L5 mm	L6 mm	UT	RF
IN-12-P6/P9	11,982	13,1	14	10	18,5	6,5	UT-12	RF-3
IN-12-P6/P9-SM	11,982	13,1	14	10	18,5	3,89	UT-12	RF-3
IN-12-H7/JS9	12,018	13,1	14	10	18,5	6,5	UT-12	RF-3
IN-12-H7/JS9-SM	12,018	13,1	14	10	18,5	3,89	UT-12	RF-3
IN-12-D10	12,120	13,1	14	10	18,5	6,5	UT-12	RF-3
IN-12-C11	12,205	13,1	14	10	18,5	6,5	UT-12	RF-3
IN-14-P6/P9	13,982	18	14	10	22	7	UT-14/16	RF-4
IN-14-P6/P9-SM	13,982	18	14	10	22	4,71	UT-14/16	RF-4
IN-14-H7/JS9	14,018	18	14	10	22	7	UT-14/16	RF-4
IN-14-H7/JS9-SM	14,018	18	14	10	22	4,71	UT-14/16	RF-4
IN-14-D10	14,120	18	14	10	22	7	UT-14/16	RF-4
IN-14-C11	14,205	18	14	10	22	7	UT-14/16	RF-4
IN-16-P6/P9	15,982	18	14	10	22	8	UT-14/16	RF-4
IN-16-P6/P9-SM	15,982	18	14	10	22	5,53	UT-14/16	RF-4
IN-16-H7/JS9	16,018	18	14	10	22	8	UT-14/16	RF-4
IN-16-H7/JS9-SM	16,018	18	14	10	22	5,53	UT-14/16	RF-4
IN-16-D10	16,120	18	14	10	22	8	UT-14/16	RF-4
IN-16-C11	16,205	18	14	10	22	8	UT-14/16	RF-4
IN-18-P6/P9	17,982	26	18	10	30	11	UT-18/25	RF-5
IN-18-P6/P9-SM	17,982	26	18	10	30	5,67	UT-18/25	RF-5
IN-18-H7/JS9	18,018	26	18	10	30	11	UT-18/25	RF-5
IN-18-H7/JS9-SM	18,018	26	18	10	30	5,67	UT-18/25	RF-5
IN-18-D10	18,120	26	18	10	30	11	UT-18/25	RF-5
IN-18-C11	18,205	26	18	10	30	11	UT-18/25	RF-5
IN-20-P6/P9	19,978	26	18	10	30	10	UT-18/25	RF-5
IN-20-P6/P9-SM	19,978	26	18	10	30	6,29	UT-18/25	RF-5
IN-20-H7/JS9	20,021	26	18	10	30	10	UT-18/25	RF-5
IN-20-H7/JS9-SM	20,021	26	18	10	30	6,29	UT-18/25	RF-5
IN-20-D10	20,149	26	18	10	30	10	UT-18/25	RF-5
IN-20-C11	20,240	26	18	10	30	10	UT-18/25	RF-5
IN-22-P6/P9	21,978	26	18	10	30	11	UT-18/25	RF-5
IN-22-P6/P9-SM	21,978	26	18	10	30	6,79	UT-18/25	RF-5
IN-22-H7/JS9	22,021	26	18	10	30	11	UT-18/25	RF-5
IN-22-H7/JS9-SM	22,021	26	18	10	30	6,79	UT-18/25	RF-5
IN-22-D10	22,149	26	18	10	30	11	UT-18/25	RF-5
IN-22-C11	22,240	26	18	10	30	11	UT-18/25	RF-5
IN-25-P6/P9	24,978	26	18	10	30	12	UT-18/25	RF-5
IN-25-P6/P9-SM	24,978	26	18	10	30	7,02	UT-18/25	RF-5
IN-25-H7/JS9	25,021	26	18	10	30	12	UT-18/25	RF-5
IN-25-H7/JS9-SM	25,021	26	18	10	30	7,02	UT-18/25	RF-5
IN-25-D10	25,149	26	18	10	30	12	UT-18/25	RF-5
IN-25-C11	25,240	26	18	10	30	12	UT-18/25	RF-5



3/32" - 5/16"

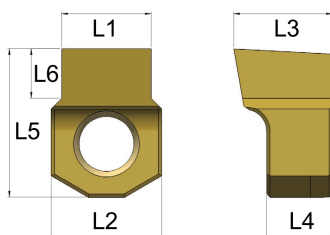

Längsnut

Rowek wpustowy wzdłużny

Platte Płytką	L1 mm	L1 inch	L2 inch	L3 inch	L4 inch	L5 inch	L6 inch	UT	RF
IN-3/32"-P6/P9	2.368	0.0932	0.1968	0.2362	0.1968	0.2559	0.0551	UT-02	RF-1
IN-3/32"-H7	2.391	0.0941	0.1968	0.2362	0.1968	0.2559	0.0551	UT-02	RF-1
IN-3/32"-D10	2.441	0.0961	0.1968	0.2362	0.1968	0.2559	0.0551	UT-02	RF-1
IN-3/32"-C11	2.500	0.0984	0.1968	0.2362	0.1968	0.2559	0.0551	UT-02	RF-1
IN-1/8"-P6/P9	3.158	0.1243	0.2393	0.2559	0.1968	0.2952	0.0905	UT-03	RF-1
IN-1/8"-H7	3.186	0.1254	0.2393	0.2559	0.1968	0.2952	0.0905	UT-03	RF-1
IN-1/8"-D10	3.252	0.1280	0.2393	0.2559	0.1968	0.2952	0.0905	UT-03	RF-1
IN-1/8"-C11	3.320	0.1307	0.2393	0.2559	0.1968	0.2952	0.0905	UT-03	RF-1
IN-5/32"-P6/P9	3.950	0.1555	0.2393	0.2755	0.1968	0.3149	0.1141	UT-04	RF-1
IN-5/32"-H7	3.981	0.1567	0.2393	0.2755	0.1968	0.3149	0.1141	UT-04	RF-1
IN-5/32"-D10	4.047	0.1593	0.2393	0.2755	0.1968	0.3149	0.1141	UT-04	RF-1
IN-5/32"-C11	4.113	0.1619	0.2393	0.2755	0.1968	0.3149	0.1141	UT-04	RF-1
IN-3/16"-P6/P9	4.745	0.1868	0.2393	0.2755	0.1968	0.3149	0.1299	UT-05	RF-1
IN-3/16"-H7	4.773	0.1879	0.2393	0.2755	0.1968	0.3149	0.1299	UT-05	RF-1
IN-3/16"-D10	4.839	0.1905	0.2393	0.2755	0.1968	0.3149	0.1299	UT-05	RF-1
IN-3/16"-C11	4.908	0.1932	0.2393	0.2755	0.1968	0.3149	0.1299	UT-05	RF-1
IN-1/4"-P6/P9	6.328	0.2491	0.3968	0.3543	0.2362	0.5314	0.1587	UT-06	RF-2
IN-1/4"-H7	6.363	0.2505	0.3968	0.3543	0.2362	0.5314	0.1587	UT-06	RF-2
IN-1/4"-D10	6.447	0.2538	0.3968	0.3543	0.2362	0.5314	0.1587	UT-06	RF-2
IN-1/4"-C11	6.518	0.2566	0.3968	0.3543	0.2362	0.5314	0.1587	UT-06	RF-2
IN-9/32"-P6/P9	7.123	0.2804	0.3968	0.3543	0.2362	0.5314	0.1692	UT-08	RF-2
IN-9/32"-H7	7.158	0.2818	0.3968	0.3543	0.2362	0.5314	0.1692	UT-08	RF-2
IN-9/32"-D10	7.242	0.2851	0.3968	0.3543	0.2362	0.5314	0.1692	UT-08	RF-2
IN-9/32"-C11	7.313	0.2879	0.3968	0.3543	0.2362	0.5314	0.1692	UT-08	RF-2
IN-5/16"-P6/P9	7.915	0.3116	0.3968	0.3543	0.2362	0.5314	0.1875	UT-08	RF-2
IN-5/16"-H7	7.951	0.3130	0.3968	0.3543	0.2362	0.5314	0.1875	UT-08	RF-2
IN-5/16"-D10	8.035	0.3163	0.3968	0.3543	0.2362	0.5314	0.1875	UT-08	RF-2
IN-5/16"-C11	8.106	0.3191	0.3968	0.3543	0.2362	0.5314	0.1875	UT-08	RF-2

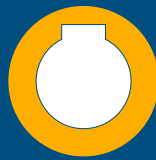

3/8" - 3/4"

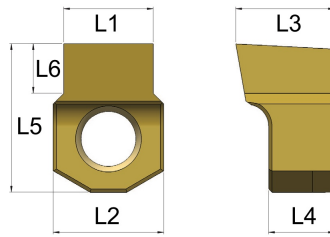

Längsnut

Rowek wpustowy wzdłużny

Platte Płytką	L1 mm	L1 inch	L2 inch	L3 inch	L4 inch	L5 inch	L6 inch	UT	RF
IN-3/8"-P6/P9	9.503	0.3741	0.5157	0.5511	0.3937	0.7283	0.2500	UT-10	RF-3
IN-3/8"-H7	9.538	0.3755	0.5157	0.5511	0.3937	0.7283	0.2500	UT-10	RF-3
IN-3/8"-D10	9.622	0.3788	0.5157	0.5511	0.3937	0.7283	0.2500	UT-10	RF-3
IN-3/8"-C11	9.693	0.3816	0.5157	0.5511	0.3937	0.7283	0.2500	UT-10	RF-3
IN-7/16"-P6/P9	11.085	0.4364	0.5157	0.5511	0.3937	0.7283	0.2500	UT-12	RF-3
IN-7/16"-H7	11.131	0.4382	0.5157	0.5511	0.3937	0.7283	0.2500	UT-12	RF-3
IN-7/16"-D10	11.232	0.4422	0.5157	0.5511	0.3937	0.7283	0.2500	UT-12	RF-3
IN-7/16"-C11	11.316	0.4455	0.5157	0.5511	0.3937	0.7283	0.2500	UT-12	RF-3
IN-1/2"-P6/P9	12.673	0.4989	0.5157	0.5511	0.3937	0.7283	0.3000	UT-12	RF-3
IN-1/2"-H7	12.718	0.5007	0.5157	0.5511	0.3937	0.7283	0.3000	UT-12	RF-3
IN-1/2"-D10	12.820	0.5047	0.5157	0.5511	0.3937	0.7283	0.3000	UT-12	RF-3
IN-1/2"-C11	12.904	0.5080	0.5157	0.5511	0.3937	0.7283	0.3000	UT-12	RF-3
IN-9/16"-P6/P9	14.260	0.5614	0.7086	0.5511	0.3937	0.8661	0.2750	UT-14/16	RF-4
IN-9/16"-H7	14.306	0.5632	0.7086	0.5511	0.3937	0.8661	0.2750	UT-14/16	RF-4
IN-9/16"-D10	14.407	0.5672	0.7086	0.5511	0.3937	0.8661	0.2750	UT-14/16	RF-4
IN-9/16"-C11	14.491	0.5705	0.7086	0.5511	0.3937	0.8661	0.2750	UT-14/16	RF-4
IN-5/8"-P6/P9	15.848	0.6239	0.7086	0.5511	0.3937	0.8661	0.3120	UT-14/16	RF-4
IN-5/8"-H7	15.893	0.6257	0.7086	0.5511	0.3937	0.8661	0.3120	UT-14/16	RF-4
IN-5/8"-D10	15.995	0.6297	0.7086	0.5511	0.3937	0.8661	0.3120	UT-14/16	RF-4
IN-5/8"-C11	16.079	0.6330	0.7086	0.5511	0.3937	0.8661	0.3120	UT-14/16	RF-4
IN-3/4"-P6/P9	19.017	0.7487	1.0240	0.7086	0.3937	1.1810	0.3930	UT-18/25	RF-4
IN-3/4"-H7	19.071	0.7508	1.0240	0.7086	0.3937	1.1810	0.3930	UT-18/25	RF-4
IN-3/4"-D10	19.198	0.7558	1.0240	0.7086	0.3937	1.1810	0.3930	UT-18/25	RF-4
IN-3/4"-C11	19.289	0.7594	1.0240	0.7086	0.3937	1.1810	0.3930	UT-18/25	RF-4



8 - 50 mm
0.32" - 1.96"

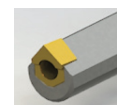
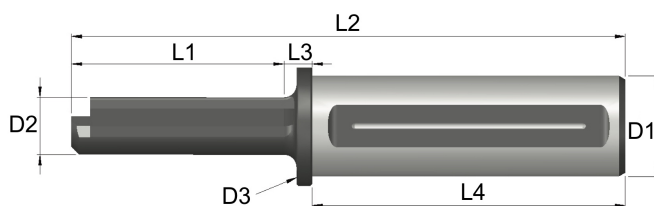

Halter Uchwyt	L1 mm	L2 mm	L3 mm	L4 mm	D1 mm	D2 mm	D3 mm	PN	T	VN	Min Ø mm
UT-SQ-8/10-25	30	129	9	90	25	7,25	30	PN-1	T08	VN-1	8
UT-SQ-10/13-25	40	139	9	90	25	8,6	30	PN-1	T08	VN-1	10
UT-SQ-13/16-25	50	149	9	90	25	12	30	PN-2	T15	VN-2	13
UT-SQ-16/19-25	52	151	9	90	25	15	30	PN-3	T20	VN-3	16
UT-SQ-19/27-25	86	185	9	90	25	18,5	30	PN-3	T20	VN-3	19
UT-SQ-27/37-25	100	199	9	90	25	25	30	PN-4	T20	VN-3	27
UT-SQ-8/10-32	30	139	9	100	32	7,25	38	PN-1	T08	VN-1	8
UT-SQ-10/13-32	40	149	9	100	32	8,6	38	PN-1	T08	VN-1	10
UT-SQ-13/16-32	50	159	9	100	32	12	38	PN-2	T15	VN-2	13
UT-SQ-16/19-32	52	161	9	100	32	15	38	PN-3	T20	VN-3	16
UT-SQ-19/27-32	86	195	9	100	32	18,5	38	PN-3	T20	VN-3	19
UT-SQ-27/37-32	100	209	9	100	32	25	38	PN-4	T20	VN-3	27
UT-SQ-37/50-32	140	249	9	100	32	35	45	PN-5	BR5	VN-4	37

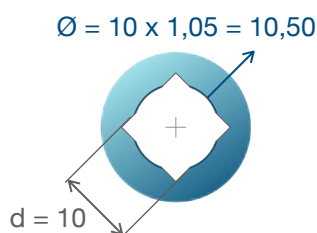
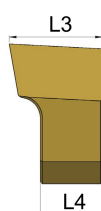
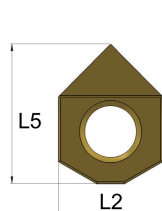

Vorbereitung / Otwór wstępny
Ø = d x 1,05

Platte Płytki	Bereich (mm) Zakres (mm)	Bereich (Zoll) Zakres (inch)	L2 mm	L3 mm	L4 mm	L5 mm	UT	RF
IN-SQ-8/10	8-10	0.314-0.393	6	7	5	7	UT-SQ-8/10	RF-1
IN-SQ-10/13	10-13	0.393-0.511	6	7	5	7,5	UT-SQ-10/13	RF-1
IN-SQ-13/16	13-16	0.511-0.629	10	8	6	12	UT-SQ-13/16	RF-2
IN-SQ-16/19	16-19	0.629-0.748	10	8	6	12,5	UT-SQ-16/19	RF-2
IN-SQ-19/27	19-27	0.748-1.062	13	13	10	17	UT-SQ-19/27	RF-3
IN-SQ-27/37	27-37	1.062-1.456	18	14	10	22	UT-SQ-27/37	RF-4
IN-SQ-37/50	37-50	1.456-1.968	26	18	10	31	UT-SQ-37/50	RF-5

Stoßwerkzeuge - Sechskant Uchwyty do dłutowania sześciokątów

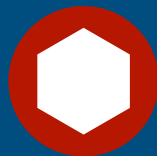

Gisstec®

9 - 70 mm
0.36" - 2.75"

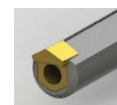
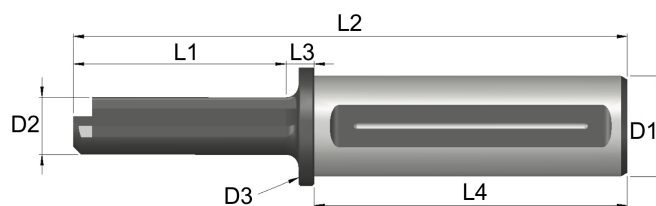

Halter Uchwyt	L1 mm	L2 mm	L3 mm	L4 mm	D1 mm	D2 mm	D3 mm	PN	T	VN	Min Ø mm
UT-HEX-9/11-25	30	129	9	90	25	8	30	PN-1	T08	VN-1	9
UT-HEX-11/17-25	40	139	9	90	25	10	30	PN-1	T08	VN-1	11
UT-HEX-17/28-25	56	155	9	90	25	15	30	PN-2	T15	VN-2	17
UT-HEX-28/37-25	86	185	9	90	25	25	30	PN-3	T20	VN-3	28
UT-HEX-37/45-25	126	225	9	90	25	35	45	PN-4	T20	VN-3	37
UT-HEX-9/11-32	30	139	9	100	32	8	38	PN-1	T08	VN-1	9
UT-HEX-11/17-32	40	149	9	100	32	10	38	PN-1	T08	VN-1	11
UT-HEX-17/28-32	56	165	9	100	32	15	38	PN-2	T15	VN-2	17
UT-HEX-28/37-32	86	195	9	100	32	25	38	PN-3	T20	VN-3	28
UT-HEX-37/45-32	126	235	9	100	32	35	45	PN-4	T20	VN-3	37
UT-HEX-45/70-32	140	249	9	100	32	40	45	PN-5	BR5	VN-4	45

Stoßplatten - Sechskant Płytki do dłutowania sześciokątów



Gisstec®

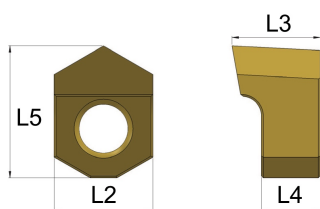

$$\text{Ø} = 10 \times 1,02 = 10,20$$

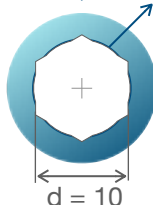

Vorbereitung / Otwór wstępny

$$\text{Ø} = d \times 1,02$$

Platte Płytką	Bereich (mm) Zakres (mm)	Bereich (Zoll) Zakres (inch)	L2 mm	L3 mm	L4 mm	L5 mm	UT	RF
IN-HEX-9/11	9-11	0.354-0.433	6	7	5	7,5	UT-HEX-9/11	RF-1
IN-HEX-11/17	11-17	0.433-0.669	6	7	5	8	UT-HEX-11/17	RF-1
IN-HEX-17/28	17-28	0.669/1.102	10	9	6	13,5	UT-HEX-17/28	RF-2
IN-HEX-28/37	28-37	1.102/1.456	13	14	10	18,5	UT-HEX-28/37	RF-3
IN-HEX-37/45	37-45	1.456/1.771	18	14	10	22	UT-HEX-37/45	RF-4
IN-HEX-45/70	45-70	1.771/2.755	26	16	10	30	UT-HEX-45/70	RF-5

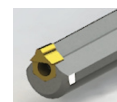
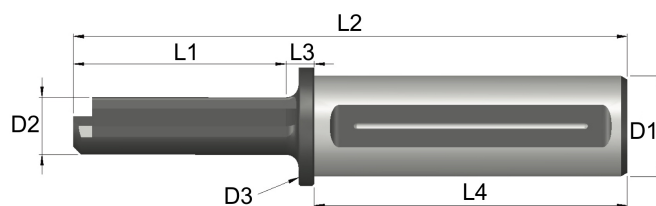
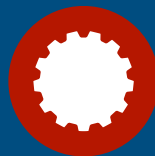

Halter Uchwyt	L1 mm	L2 mm	L3 mm	L4 mm	D1 mm	D2 mm	D3 mm	PN	T	VN	Min Ø mm
UTS-02-25	25	124	9	90	25	6,5	30	PN-1	T08	VN-1	7
UTS-03-25	30	129	9	90	25	8	30	PN-1	T08	VN-1	8,5
UTS-04-25	40	139	9	90	25	10	30	PN-1	T08	VN-1	10,5
UTS-05-25	46	145	9	90	25	12	30	PN-1	T08	VN-1	12,5
UTS-06-25	56	155	9	90	25	16	30	PN-2	T15	VN-2	16,5
UTS-08-25	68	162	9	90	25	20	30	PN-2	T15	VN-2	21
UTS-10-25	86	185	9	90	25	25	30	PN-3	T20	VN-3	28
UTS-12-25	102	203	9	90	25	30	30	PN-3	T20	VN-3	33
UTS-14/16-25	126	221	5	90	25	35	37	PN-4	T20	VN-3	38
UTS-02-32	25	134	9	100	32	6,5	37	PN-1	T08	VN-1	7
UTS-03-32	30	139	9	100	32	8	37	PN-1	T08	VN-1	8,5
UTS-04-32	40	149	9	100	32	10	37	PN-1	T08	VN-1	10,5
UTS-05-32	46	155	9	100	32	12	37	PN-1	T08	VN-1	12,5
UTS-06-32	56	165	9	100	32	16	37	PN-2	T15	VN-2	16,5
UTS-08-32	68	172	9	100	32	20	37	PN-2	T15	VN-2	21
UTS-10-32	86	195	9	100	32	25	37	PN-3	T20	VN-3	28
UTS-12-32	102	213	9	100	32	30	37	PN-3	T20	VN-3	33
UTS-14/16-32	126	231	9	100	32	35	37	PN-4	T20	VN-3	38
UTS-18/25-32	140	249	9	100	32	40	45	PN-5	BR.5	VN-4	42



- ✓ Platten für Verzahnungsprofile werden nach Kundenzeichnung gefertigt.
- ✓ Mindestbestellmenge: Zwei Stück
- ✓ Sonderpreis ab 10 Stück



- ✓ Płytki do profili uzębionych produkowane są zgodnie z wymaganiami technicznymi klienta
- ✓ Minimalna wielkość zamówienia: 2 sztuki
- ✓ Specjalna cena przy zamówieniach powyżej 10 sztuk

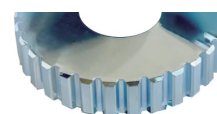
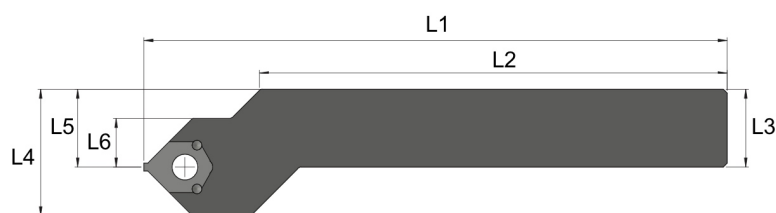

Halter Uchwyt	L1 mm	L2 mm	L3 mm	L4 mm	L5 mm	L6 mm
UTE-20-DX	150	110	20x20	32,5	20	12,5
UTE-20-SX	150	110	20x20	32,5	20	12,5
UTE-25-DX	150	110	25x25	37,5	25	12,5
UTE-25-SX	150	110	25x25	37,5	25	12,5

Mini-Nutstoßwerkzeuge
Mini narzędzia do dłutowania

Halter
Uchwyt

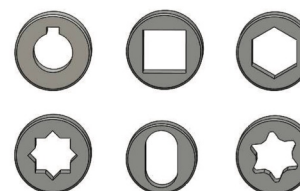
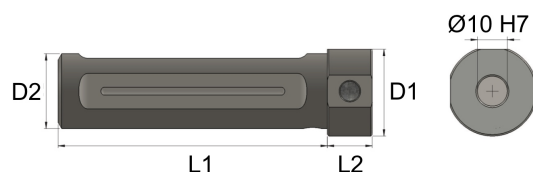

Halter Uchwyt	L1 mm	L2 mm	D1 mm	D2 mm
UT-1/8-19.05	90	15	30	19,05
UT-1/8-20	90	15	30	20
UT-1/8-25	90	15	30	25
UT-1/8-32	100	15	38	32

Platte
Wkład / Mini dłutak

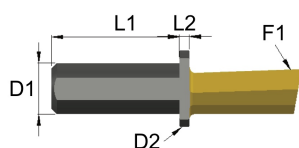

Platte Wkład	L1 mm	L2 mm	F1 mm	D1 mm	D2 mm
IN-1/8	18	2	Auf Anfrage Na zamówienie	10 H7	15

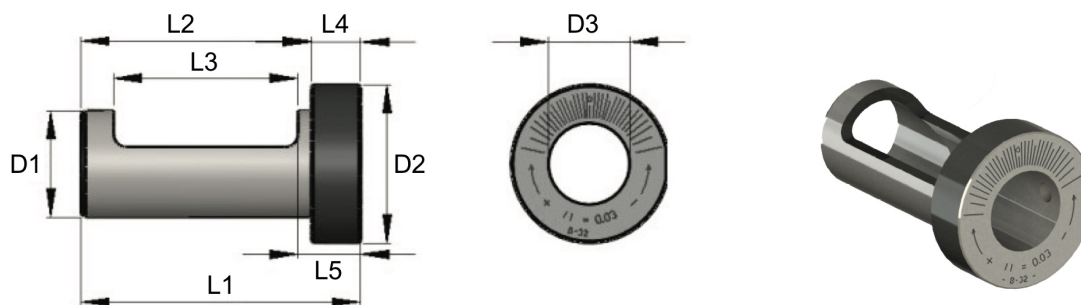

Buchse Tuleja	L1 mm	L2 mm	L3 mm	L4 mm	L5 mm	D1 mm	D2 mm	D3 mm
B-32	85	70	58	15	20	32 H7	48	25
B-40	95	80	66	15	20	40 H7	55	32
B-50	115	100	75	15	20	50 H7	65	32
B-60	115	100	75	15	20	60 H7	80	32
B-32-VDI	65	50	38	15	20	32 H7	48	25
B-40-VDI	80	65	51	15	20	40 H7	55	32
B-50-VDI	95	80	55	15	20	50 H7	65	32
B-60-VDI	105	80	65	15	20	60 H7	80	32

Buchse Tuleja	L1 inch	L2 inch	L3 inch	L4 inch	L5 inch	D1 inch	D2 inch	D3 inch
B-1-1/4in	3.346	2.756	2.283	0.591	0.787	1.25	2 165	0.984
B-1-1/2in	3.740	3.150	2.598	0.591	0.787	1.50	2 165	1.260
B-2in	4.528	3.937	2.953	0.591	0.787	2.00	2 559	1.260
B-1-1/4in-VDI	2.559	1.969	1.496	0.591	0.787	1.25	2 165	0.984
B-1-1/2in-VDI	3.150	2.559	2.008	0.591	0.787	1.50	2 165	1.260
B-2in-VDI	3.740	3.150	2.165	0.591	0.787	2.00	2 559	1.260

- ✓ Exzenterische Buchse für Drehmaschinen ohne Y-Achse, zur Achsen-Korrektur
- ✓ Gefertigt aus gehärtetem Werkzeugstahl
- ✓ Verstellung auf Y-Achse:
0,5 mm Y+
0,5 mm Y-

- ✓ Tuleja mimośrodowa jest niezbędna w przypadku tokarek bez osi Y, służy do jej korekcji
- ✓ Wykonanie z hartowanej stali narzędziowej
- ✓ Korekta na osi Y:
0,5 mm Y+
0,5 mm Y-

AD

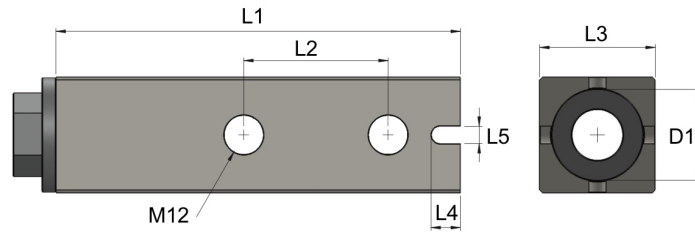

Adapter	L1 mm	L2 mm	L3 mm	L4 mm	L5 mm	D1 mm
AD-35	140	40	35	10	6	25
AD-40	140	50	40	10	6	32
AD-50	170	50	50	10	6	32

ADP Pryzma

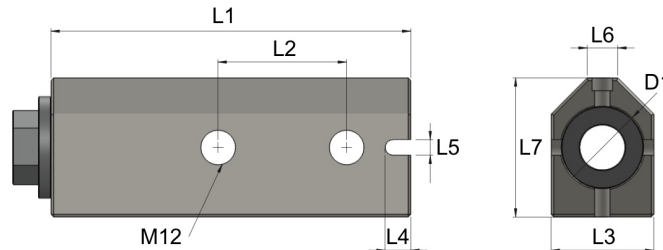

Adapter	L1 mm	L2 mm	L3 mm	L4 mm	L5 mm	L6 mm	L7 mm	D1 mm
ADP-35	140	40	35	10	6	10	41,5	25
ADP-40	140	50	40	10	6	10	50	32
ADP-50	140	50	50	10	6	10		32

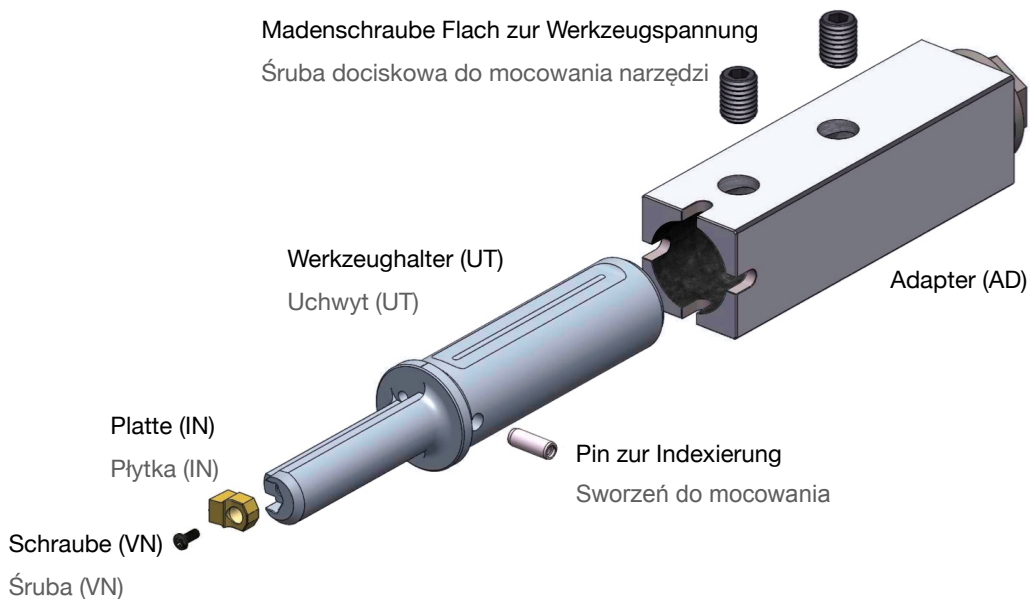

Ausrichthilfe für Bearbeitungszentren (PN)

Пłyта centrująca do centr obróbczych CNC (PN)

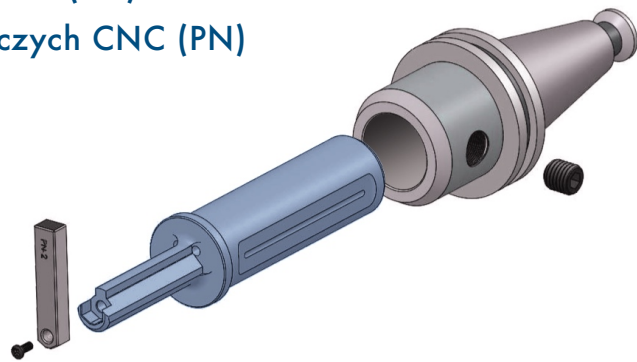
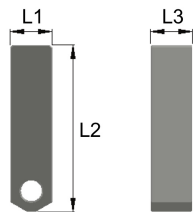

Artikelnr. Kod	L1 mm	L2 mm	L3 mm	Werkzeuge Narzędzia
PN-0	5	50	6	UT-02
PN-1	6,08	50	8	UT-03, UT-04, UT-05
PN-2	10,08	50	8	UT-06, UT-08
PN-3	13,1	60	10	UT-10, UT-12
PN-4	18	70	10	UT-14/16
PN-5	26	70	10	UT-18/25

Nachschleifhalter (RF)

Uchwyt do ostrzenia (RF)

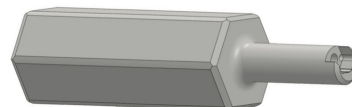
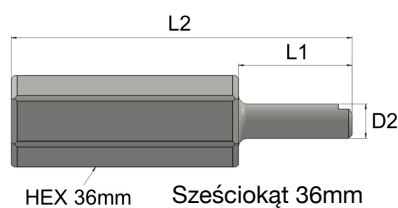

Artikelnr. Kod	L1 mm	L2 mm	D2 mm	Platten Płytki
RF-0	50	150	10	2 mm
RF-1	50	150	12	3-4-5 mm
RF-2	50	150	15	6-8 mm
RF-3	50	150	20	10-12 mm
RF-4	50	150	25	14-16 mm
RF-5	50	150	32	18-25 mm

Torx-Schrauben für Platten (VN)
Śruby Torx do mocowania płytek (VN)



Artikelnr. Kod	Typ Typ	Größe Rozmiar	Werkzeuge Narzędzia
VN-1	TORX	M2,5x8	UT-02, UT-03, UT-04, UT-05
VN-2	TORX	M4x10	UT-06, UT-08
VN-3	TORX	M6x15	UT-10, UT-12, UT-14/16
VN-4	TCEI	M8x16	UT-18/25

Kugeldruckschraube (BU)
Kulkowa śruba dociskowa (BU)



Artikelnr. Kod	Größe Rozmiar	Länge (mm) Długość (mm)
BU-1	M6x15	15
BU-2	M8x20	20
BU-3	M10x20	20
BU-4	M12x25	25
BU-5	M14x25	25
BU-6	M16x30	30

Artikelnr. Kod	Größe Rozmiar	Länge (mm) Długość (mm)
BU-7	UNC 5/16" - 18	37/64"
BU-8	UNC 3/8" - 16	5/8"
BU-9	UNV 1/2" - 13	3/4"
BU-10	UNC 5/8" - 11	36/64"

- Um Werkzeughalter (UT) in den Bohrstangenhalter zu spannen auf Drehmaschinen.
- Hält Halter fest, beim verstellen mithilfe Exzenterbuchse.

- Do mocowania uchwytów do dłutowania (UT) imaku tokarskim na tokarkach CNC
- Utrzymuje uchwyt we właściwym położeniu podczas korygowania błędów położenia w osi za pomocą tulei mimośrodowej.

- ☑ Nuten, Vierkant, Sechskant und Verzahnungsprofile auf Drehmaschinen Stoßen
- ☑ Dłutowanie rowków wpustowych, profili kwadratowych, sześciokątnych, specjalnych i ewolwentowych na tokarce

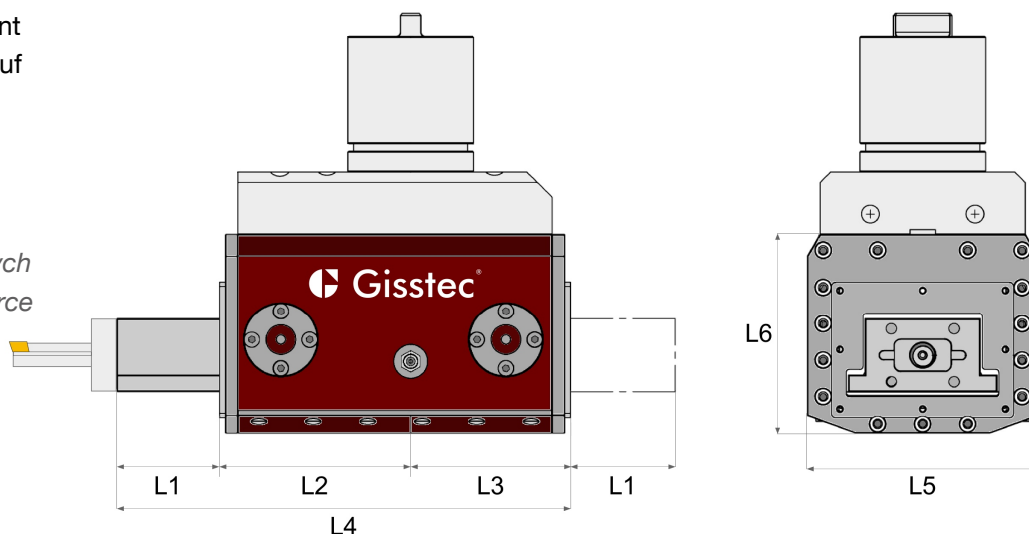

Artikelnr. Kod	Hub Skok	Hub (Zoll) Skok (cale)	L1 mm	L2 mm	L3 mm	L4 mm	L5 mm	L6 mm
NG-17	15 mm	0.59"	17	39,25	39,25	95,5	54	50,5
NG-27	25 mm	0.98"	27	50	48	125	63	52
NG-35	33 mm	1.29"	35	76,5	76	187,5	100	95
NG-50	48 mm	1.88"	50	90,5	76	216,5	110	95
NG-65	63 mm	2.48"	65	106,5	76,5	248	125	95



- ☑ Perfekte Symmetrie: Y-Achsenverstellung $\pm 0,3$
- ☑ Parallelitätsverstellung auf Z-Achse $\pm 0,3$
- ☑ Max. 1000 U/min
- ☑ 1 U/min = 1 Hub
- ☑ Innen- und Außenbearbeitung

Patentiert
Opatentowane

- ☑ *Perfekcyjna symetria: regulacja osi Y $\pm 0,3$*
- ☑ *Regulacja osiowa na osi Z $\pm 0,3$*
- ☑ *Maks. 1000 obr/min*
- ☑ *Obr/min = 1 skok*
- ☑ *Obróbka powierzchni wewnętrznych i zewnętrznych*

Patentiert
Opatentowane



Material Materiał	Max. Nutenbreite /Maks. szerokość rowka wpustowego			Schnittgeschw. Prędkość skrawania	Schnitttiefe Głębokość obróbki
	NG-35	NG-50	NG-65		
Aluminium	16mm	16mm	16mm	38 m/min.	0,06 / 0,15 mm
Stal miękka	14mm	14mm	14mm	33 m/min.	0,04 / 0,07 mm
Żeliwo	14mm	14mm	12mm	28 m/min.	0,04 / 0,07 mm
Stal zwykła	14mm	14mm	12mm	30 m/min.	0,03 / 0,05 mm
Stal hartowana	12mm	12mm	10mm	25 m/min.	0,02 / 0,04 mm
Stal nierdzewna	12mm	12mm	10mm	25 m/min.	0,02 / 0,04 mm
Plastik	18mm	18mm	18mm	40 m/min.	0,07 / 0,15 mm
Brąz-Mosiądz	14mm	12mm	12mm	30 m/min.	0,03 / 0,06 mm

Max  37mm / 1,45"

Max  45mm / 1,77"

Wartung

- Alle 1.000 Betriebsstunden: Allgemeine Wartung, Verschleißteile ersetzen.

Konserwacja

- Co 1000 godzin pracy: konserwacja ogólna, wymiana części podlegających zużyciu.

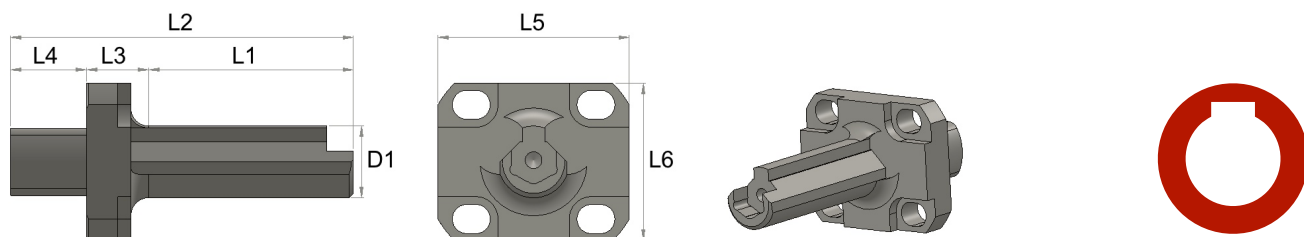

Artikelnr. Kod	L1 mm	L2 mm	L3 mm	L4 mm	L5 mm	L6 mm	D1 mm	PN	T	VN	Min Ø mm
NG-35											
UTM-02	25	58	13	20	43	35	6	PN-0	T08	VN-1	7
UTM-03	30	63	13	20	43	35	8	PN-1	T08	VN-1	8,7
UTM-04	40	73	13	20	43	35	10	PN-1	T-08	VN-1	11
UTM-05	46	79	13	20	43	35	12	PN-1	T-08	VN-1	13
UTM-06-35	46	79	13	20	43	35	16	PN-2	T-15	VN-2	17
UTM-08-35	46	79	13	20	43	35	20	PN-2	T-15	VN-2	21,5
UTM-10/12-35	46	79	13	20	43	35	22	PN-3	T-20	VN-3	24
UTM-14/16-35	46	79	13	20	43	35	25	PN-4	T-20	VN-3	27
NG-50											
UTM-02	25	58	13	20	43	35	6	PN-0	T08	VN-1	7
UTM-03	30	63	13	20	43	35	8	PN-1	T08	VN-1	8,7
UTM-04	40	73	13	20	43	35	10	PN-1	T-08	VN-1	11
UTM-05	46	79	13	20	43	35	12	PN-1	T-08	VN-1	13
UTM-06-50/65	56	89	13	20	43	35	16	PN-2	T-15	VN-2	17
UTM-08-50	56	89	13	20	43	35	20	PN-2	T-15	VN-2	21,5
UTM-10/12-50	56	89	13	20	43	35	22	PN-3	T-20	VN-3	24
UTM-14/16-50	56	89	13	20	43	35	25	PN-4	T-20	VN-3	27
NG-65											
UTM-02	25	58	13	20	43	35	6	PN-0	T08	VN-1	7
UTM-03	30	63	13	20	43	35	8	PN-1	T08	VN-1	8,7
UTM-04	40	73	13	20	43	35	10	PN-1	T-08	VN-1	11
UTM-05	46	79	13	20	43	35	12	PN-1	T-08	VN-1	13
UTM-06-50/65	56	89	13	20	43	35	16	PN-2	T-15	VN-2	17
UTM-08-65	68	102	13	20	43	35	20	PN-2	T-15	VN-2	21,5
UTM-10/12-65	70	103	13	20	43	35	22	PN-3	T-20	VN-3	24
UTM-14/16-65	70	103	13	20	43	35	25	PN-4	T-20	VN-3	27

* Bei Bestellung Marke/Modell des Nutstoßgerätes angeben

* Przy zamówieniu prosimy o podanie marki/modelu posiadanej oprawki napędzanej do dłutowania

Vierkant / Kwadraty

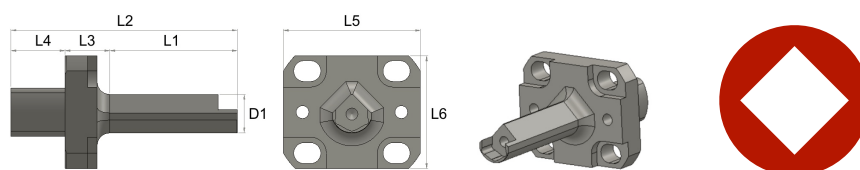

Artikelnr. Kod	L1 mm	L2 mm	L3 mm	L4 mm	L5 mm	L6 mm	D1 mm	PN	T	VN	Min Ø mm
NG-35											
UTM-SQ-8/10	30	58	13	20	43	35	7,25	PN-1	T08	VN-1	8
UTM-SQ-10/13	40	63	13	20	43	35	8,6	PN-1	T08	VN-1	10
UTM-SQ-13/16-35	46	73	13	20	43	35	12	PN-2	T-15	VN-2	13
UTM-SQ-16/19-35	46	79	13	20	43	35	15	PN-3	T-20	VN-3	16
UTM-SQ-19/27-35	46	79	13	20	43	35	18,5	PN-3	T-20	VN-3	19
UTM-SQ-27/37-35	46	79	13	20	43	35	25	PN-4	T-20	VN-3	27
NG-50											
UTM-SQ-8/10	30	58	13	20	43	35	7,25	PN-1	T08	VN-1	8
UTM-SQ-10/13	40	63	13	20	43	35	8,6	PN-1	T08	VN-1	10
UTM-SQ-13/16-50/65	52	77	13	20	43	35	12	PN-2	T-15	VN-2	13
UTM-SQ-16/19-50/65	52	87	13	20	43	35	15	PN-3	T-20	VN-3	16
UTM-SQ-19/27-50	60	93	13	20	43	35	18,5	PN-3	T-20	VN-3	19
UTM-SQ-27/37-50	60	93	13	20	43	35	25	PN-4	T-20	VN-3	27
NG-65											
UTM-SQ-8/10	30	58	13	20	43	35	7,25	PN-1	T08	VN-1	8
UTM-SQ-10/13	40	63	13	20	43	35	8,6	PN-1	T08	VN-1	10
UTM-SQ-13/16-50/65	52	77	13	20	43	35	12	PN-2	T-15	VN-2	13
UTM-SQ-16/19-50/65	52	87	13	20	43	35	15	PN-3	T-20	VN-3	16
UTM-SQ-19/27-65	75	108	13	20	43	35	18,5	PN-3	T-20	VN-3	19
UTM-SQ-27/37-65	75	108	13	20	43	35	25	PN-4	T-20	VN-3	27

Sechskant / Sześciokąt

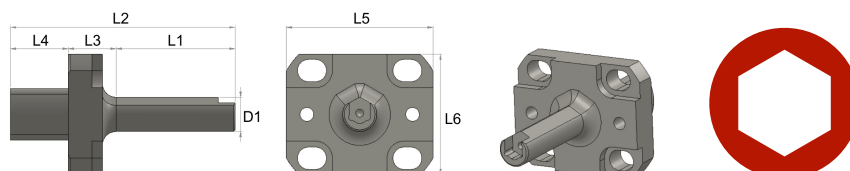

Artikelnr. Kod	L1 mm	L2 mm	L3 mm	L4 mm	L5 mm	L6 mm	D1 mm	PN	T	VN	Min Ø mm
NG-35											
UTM-HEX-9/11	30	58	13	20	43	35	8	PN-1	T08	VN-1	8,7
UTM-HEX-11/17	40	63	13	20	43	35	10	PN-1	T08	VN-1	10
UTM-HEX-17/28-35	46	77	13	20	43	35	15	PN-2	T-15	VN-2	16
UTM-HEX-28/37-35	46	79	13	20	43	35	25	PN-3	T-20	VN-3	27
UTM-HEX-37/45-35	46	79	13	20	43	35	28	PN-4	T-20	VN-3	30
NG-50											
UTM-HEX-9/11	30	58	13	20	43	35	8	PN-1	T08	VN-1	8,7
UTM-HEX-11/17	40	63	13	20	43	35	10	PN-1	T08	VN-1	10
UTM-HEX-17/28-50	60	93	13	20	43	35	15	PN-2	T-15	VN-2	16
UTM-HEX-28/37-50	60	93	13	20	43	35	25	PN-3	T-20	VN-3	27
UTM-HEX-37/45-50	60	93	13	20	43	35	28	PN-4	T-20	VN-3	30
NG-65											
UTM-HEX-9/11	30	58	13	20	43	35	8	PN-1	T08	VN-1	8,7
UTM-HEX-11/17	40	63	13	20	43	35	10	PN-1	T08	VN-1	10
UTM-HEX-17/28-65	60	87	13	20	43	35	15	PN-2	T-15	VN-2	16
UTM-HEX-28/37-65	75	108	13	20	43	35	25	PN-3	T-20	VN-3	27
UTM-HEX-37/45-65	75	108	13	20	43	35	28	PN-4	T-20	VN-3	30

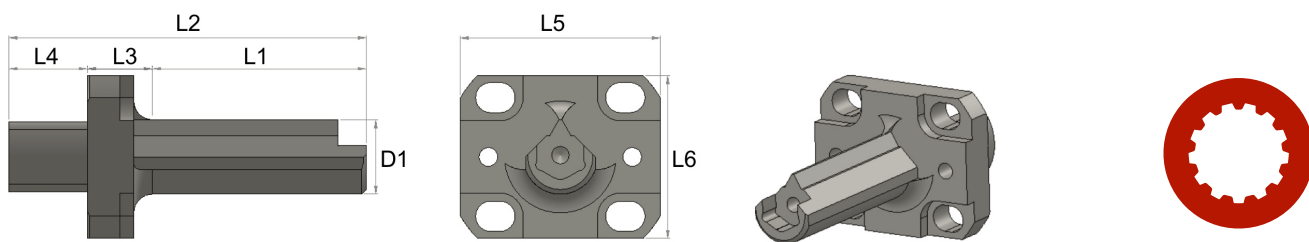

Artikelnr. Kod	L1 mm	L2 mm	L3 mm	L4 mm	L5 mm	L6 mm	D1 mm	PN	T	VN	Min Ø mm
NG-35											
UTM-S-02	25	58	13	20	43	35	6,5	PN-0	T08	VN-1	7
UTM-S-03	30	63	13	20	43	35	8	PN-1	T08	VN-1	8,7
UTM-S-04	40	73	13	20	43	35	10	PN-1	T-08	VN-1	11
UTM-S-05	46	79	13	20	43	35	12	PN-1	T-08	VN-1	13
UTM-S-06-35	46	79	13	20	43	35	16	PN-2	T-15	VN-2	17
UTM-S-08-35	46	79	13	20	43	35	20	PN-2	T-15	VN-2	21,5
UTM-S-10-35	46	79	13	20	43	35	22	PN-3	T-20	VN-3	24
UTM-S-12-35	46	79	13	20	43	35	25	PN-3	T-20	VN-3	27
UTM-S-14/16-35	46	79	13	20	43	35	28	PN-4	T-20	VN-3	30
NG-50											
UTM-S-02	25	58	13	20	43	35	6,5	PN-0	T08	VN-1	7
UTM-S-03	30	63	13	20	43	35	8	PN-1	T08	VN-1	8,7
UTM-S-04	40	73	13	20	43	35	10	PN-1	T-08	VN-1	11
UTM-S-05	46	79	13	20	43	35	12	PN-1	T-08	VN-1	13
UTM-S-06-50/65	56	89	13	20	43	35	16	PN-2	T-15	VN-2	17
UTM-S-08-50	60	93	13	20	43	35	20	PN-2	T-15	VN-2	21,5
UTM-S-10-50	60	93	13	20	43	35	22	PN-3	T-20	VN-3	24
UTM-S-12-50	60	93	13	20	43	35	25	PN-3	T-20	VN-3	27
UTM-S-14/16-50	60	93	13	20	43	35	28	PN-4	T-20	VN-3	30
NG-65											
UTM-S-02	25	58	13	20	43	35	6,5	PN-0	T08	VN-1	7
UTM-S-03	30	63	13	20	43	35	8	PN-1	T08	VN-1	8,7
UTM-S-04	40	73	13	20	43	35	10	PN-1	T-08	VN-1	11
UTM-S-05	46	79	13	20	43	35	12	PN-1	T-08	VN-1	13
UTM-S-06-50/65	60	79	13	20	43	35	16	PN-2	T-15	VN-2	17
UTM-S-08-65	70	100	13	20	43	35	20	PN-2	T-15	VN-2	21,5
UTM-S-10-65	75	108	13	20	43	35	22	PN-3	T-20	VN-3	24
UTM-S-12-65	75	108	13	20	43	35	25	PN-3	T-20	VN-3	27
UTM-S-14/16-65	75	108	13	20	43	35	28	PN-4	T-20	VN-3	30

Mini-Plattenhalter für Nutstoßgeräte
Mini oprawka do dłutowania

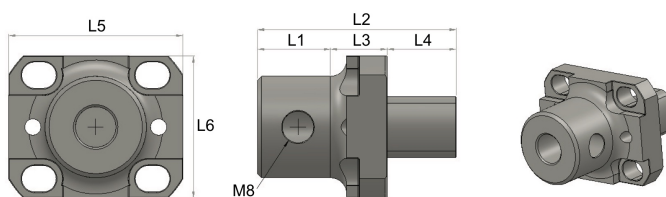

NG-35/NG-50/NG-65	L1 mm	L2 mm	L3 mm	L4 mm	L5 mm	L6 mm	€
UTM-M	20	50	15	20	43	35	400 €

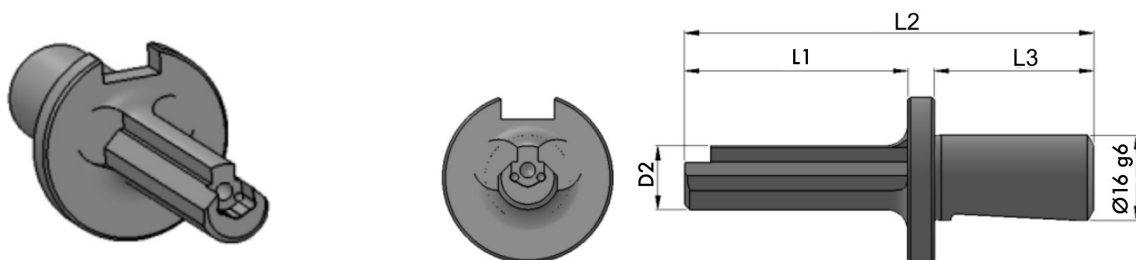

Artikelnr. Kod	L1 mm	L2 mm	L3 mm	D1 mm	D2 mm	D3 mm	Min. otwór wstępny (mm)	Uchwyt do ostrzenia	Śrubokręt	Śruba mocująca
UTM-02	25	60	30	16 g6	6,5	7	7	RF-0	T-08	VN-1
UTM-03	30	65	30	16 g6	8	30	8,5	RF-1	T-08	VN-1
UTM-04	40	75	30	16 g6	11	30	10	RF-1	T-08	VN-1
UTM-05	46	81	30	16 g6	12	30	13	RF-1	T-08	VN-1
UTM-06	56	91	30	16 g6	16	30	17	RF-2	T-15	VN-2
UTM-08	60	95	30	16 g6	20	30	21	RF-2	T-15	VN-2
UTM-10	60	95	30	16 g6	22	30	24	RF-3	T-20	VN-3

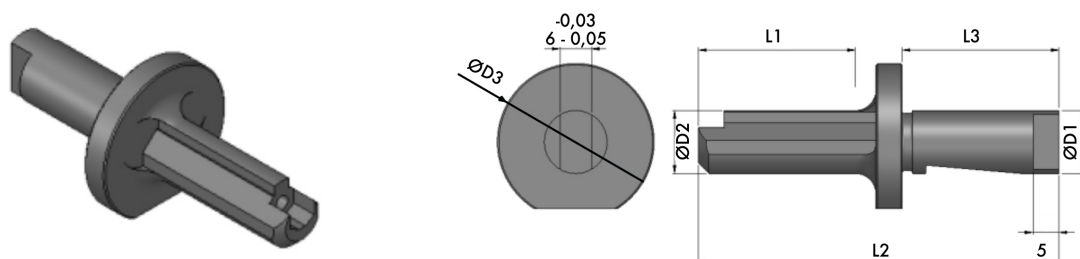

Artikelnr. Kod	L1 mm	L2 mm	L3 mm	D1 mm	D2 mm	D3 mm	Min. otwór wstępny (mm)	Uchwyt do ostrzenia	Śrubokręt	Śruba mocująca
UTM-02	25	30	5	12 g6	6,5	25	7	RF-0	T-08	VN-1
UTM-03	30	30	5	12 g6	8	25	8,5	RF-1	T-08	VN-1
UTM-04	40	30	5	12 g6	11	25	10	RF-1	T-08	VN-1
UTM-05	46	30	5	12 g6	12	25	13	RF-1	T-08	VN-1
UTM-06	56	30	5	12 g6	16	25	17	RF-2	T-15	VN-2
UTM-08	60	30	5	12 g6	20	25	21	RF-2	T-15	VN-2
UTM-10	60	30	5	12 g6	22	25	24	RF-3	T-20	VN-3

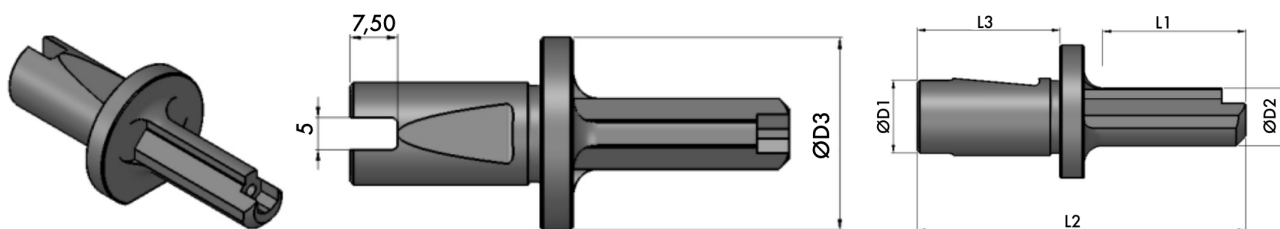

Artikelnr. Kod	L1 mm	L2 mm	L3 mm	D1 mm	D2 mm	D3 mm	Min. otwór wstępny (mm)	Uchwyt do ostrzenia	Śrubokręt	Śruba mocująca
UTM-02	25	64	30	16 g6	6,5	16	7	RF-0	T-08	VN-1
UTM-03	30	69	30	16 g6	8	16	8,5	RF-1	T-08	VN-1
UTM-04	40	79	30	16 g6	11	16	10	RF-1	T-08	VN-1
UTM-05	46	85	30	16 g6	12	116	13	RF-1	T-08	VN-1
UTM-06	56	95	30	16 g6	16	25	17	RF-2	T-15	VN-2
UTM-08	60	99	30	16 g6	20	25	21	RF-2	T-15	VN-2
UTM-10	60	99	30	16 g6	22	25	24	RF-3	T-20	VN-3

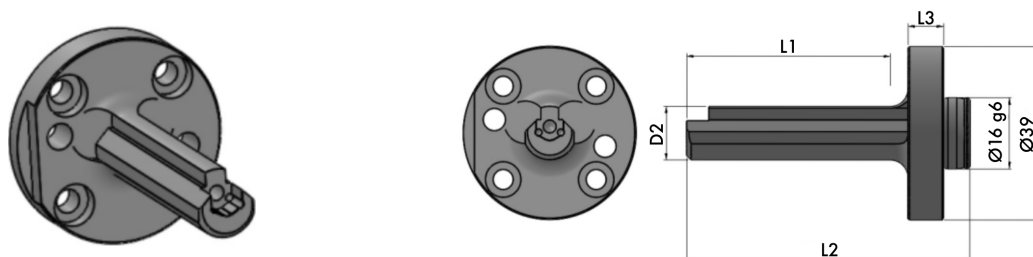

Artikelnr. Kod	L1 mm	L2 mm	L3 mm	D1 mm	D2 mm	D3 mm	Min. otwór wstępny (mm)	Uchwyt do ostrzenia	Śrubokręt	Śruba mocująca
UTM-02	25	43	8	16 g6	6,5	39	7	RF-0	T-08	VN-1
UTM-03	30	48	8	16 g6	8	39	8,5	RF-1	T-08	VN-1
UTM-04	40	58	8	16 g6	11	39	10	RF-1	T-08	VN-1
UTM-05	46	64	8	16 g6	12	39	13	RF-1	T-08	VN-1
UTM-06	56	74	8	16 g6	16	39	17	RF-2	T-15	VN-2
UTM-08	60	78	8	16 g6	20	39	21	RF-2	T-15	VN-2
UTM-10	60	78	8	16 g6	22	39	24	RF-3	T-20	VN-3

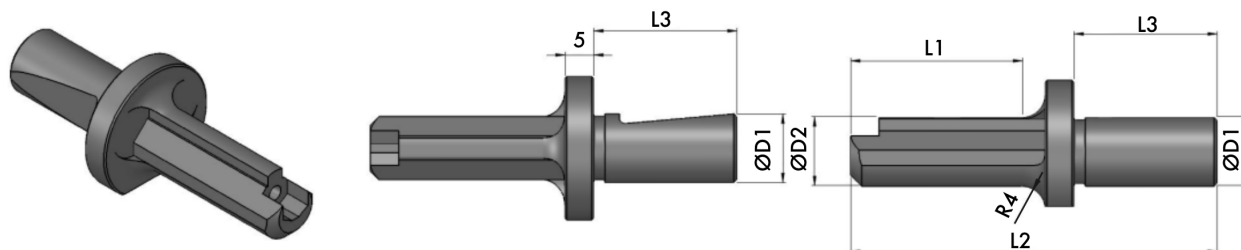

Artikelnr. Kod	L1 mm	L2 mm	L3 mm	D1 mm	D2 mm	D3 mm	Min. otwór wstępny (mm)	Uchwyt do ostrzenia	Śrubokręt	Śruba mocująca
UTM-02	25	68	34	15 g6	6,5	25	7	RF-0	T-08	VN-1
UTM-03	30	73	34	15 g6	8	25	8,5	RF-1	T-08	VN-1
UTM-04	40	83	34	15 g6	11	25	11	RF-1	T-08	VN-1
UTM-05	46	89	34	15 g6	12	25	13	RF-1	T-08	VN-1
UTM-06	56	99	34	15 g6	16	25	17	RF-2	T-15	VN-2
UTM-08	60	103	34	15 g6	20	25	21	RF-2	T-15	VN-2
UTM-10	60	103	34	15 g6	22	25	24	RF-3	T-20	VN-3

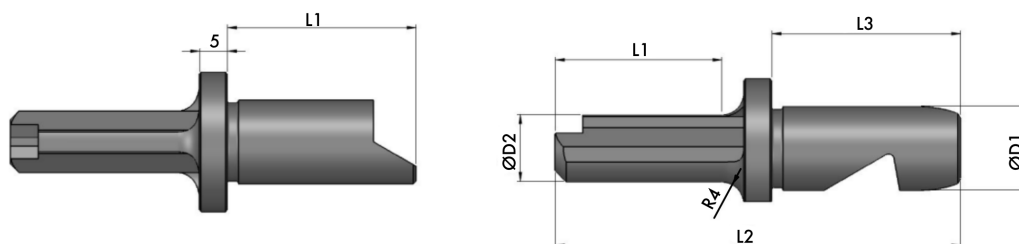

Artikelnr. Kod	L1 mm	L2 mm	L3 mm	D1 mm	D2 mm	D3 mm	Min. otwór wstępny (mm)	Uchwyt do mocowania	Śrubokręt	Śruba mocująca
UTM-02	25	68	34	15 g6	6,5	25	7	RF-0	T-08	VN-1
UTM-03	30	73	34	15 g6	8	25	8,5	RF-1	T-08	VN-1
UTM-04	40	83	34	15 g6	11	25	11	RF-1	T-08	VN-1
UTM-05	46	89	34	15 g6	12	25	13	RF-1	T-08	VN-1
UTM-06	56	99	34	15 g6	16	25	17	RF-2	T-15	VN-2
UTM-08	60	103	34	15 g6	20	25	21	RF-2	T-15	VN-2
UTM-10	60	103	34	15 g6	22	25	24	RF-3	T-20	VN-3



KIT-625 **KIT-632**
KIT-625-L **KIT-632-L**

- ✓ UT-03, 04, 05, 06, 08, 10 - 6 uchwytów
- ✓ B32 / B40 / AD35 / AD40 - do wyboru 1 tuleja lub adapter
- ✓ 12 Platten / 12 płytek w zestawie
- ✓ RF-1, RF-2, RF-3 - 3 uchwyty do ostrzenia płytek
- ✓ 3 Schraubendreher / 3 śrubokręty
- ✓ Werkzeughalterbasis / Baza do uchwytów



KIT-725 **KIT-732**
KIT-725-L **KIT-732-L**

- ✓ UT-03, 04, 05, 06, 08, 10, 12 - 7 uchwytów
- ✓ B32 / B40 / AD35 / AD40 - do wyboru 1 tuleja lub adapter
- ✓ 14 Platten / 14 płytek w zestawie
- ✓ RF-1, RF-2, RF-3 - 3 uchwyty do ostrzenia płytek
- ✓ 3 Schraubendreher / 3 śrubokręty
- ✓ Werkzeughalterbasis / Baza do uchwytów



KIT-825 **KIT-832**
KIT-825-L **KIT-832-L**

- ✓ UT-03, 04, 05, 06, 08, 10, 12, 14/16 - 8 uchwytów
- ✓ B32 / B40 / AD35 / AD40 - do wyboru 1 tuleja lub adapter
- ✓ 18 Platten / 18 płytek w zestawie
- ✓ RF-1, RF-2, RF-3, RF-4 - 4 uchwyty do ostrzenia płytek
- ✓ 3 Schraubendreher / 3 śrubokręty
- ✓ Werkzeughalterbasis / Baza do uchwytów

Material	Schnittgeschw. Prędkość skrawania	Schnitttiefe (mm) Głębokość dłutowania (mm)	Empfohlene Schnitttiefe (mm) Zalecana głębokość dłutowania (mm)
Aluminium Aluminium	10 m/min	0,10 - 0,25	0,20
Weichstahl Stal miękka	8 m/min	0,06 - 0,15	0,11
Gusseisen Żeliwo	6 m/min	0,06 - 0,20	0,13
Stahl Stal zwykła	6 m/min	0,04 - 0,12	0,08
Gehärteter Stahl Stal hartowana	5 m/min	0,03 - 0,08	0,06
Edelstahl Stal nierdzewna	5 m/min	0,03 - 0,08	0,06
Kunststoff Plastik	10 m/min	0,20 - 0,30	0,25
Bronze, Messing Brąz, mosiądz	7 m/min	0,05 - 0,15	0,10

- * Für Nuten mit einer Breite über 18 mm empfehlen wir eine Rohbearbeitung mit einer 12-mm-Platte im Vorfeld.
- * *W przypadku rowków wpustowych o szerokości większej niż 18 mm zaleca się najpierw obróbkę zgrubną przy użyciu płytek 12 mm.*

Die Belastung auf der Maschinen-
spindel während einer Nutenstoß-
bearbeitung von 20 mm entspricht
einer Bohrbearbeitung von Ø14 mm.

Obciążenie wrzeciona maszyny
podczas operacji dłutowania
rowków wpustowych o długości 20
mm odpowiada operacji wiercenia o
Ø14 mm



Tradensa
TOOLS AND MACHINE PARTS

 **Gisstec**[®]

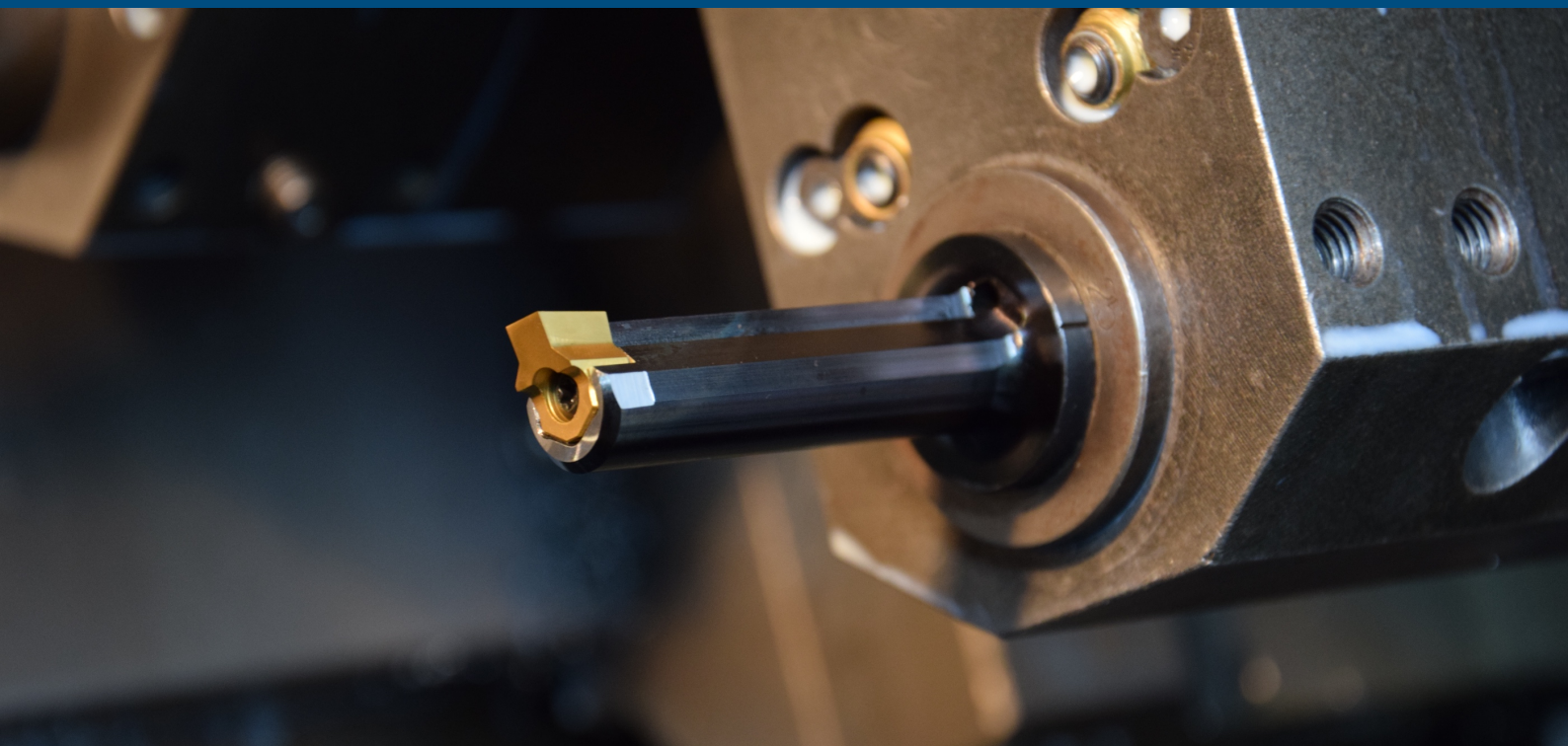

Tradensa Sp. z o. o.

Ul. Urocza 5a
62-081 Wysogotowo
Polska

Tel +48 733 003 535

sprzedaz@tradensa.pl
www.tradensa.pl

PRZEDSTAWICIEL W POLSCE

Gisstec GmbH

Ackerstr. 20
40233 Düsseldorf
Niemcy

Tel +49 211 2486 3666
Fax +49 211 9859 3175

info@gisstec.com
www.gisstec.com

www.broachingtool.net